

**CHANNEL SYSTEMS, INC.**  
 74 - 98th Avenue  
 Oakland, CA 94603  
 phone: 510-568-7288  
 fax: 510-568-4619

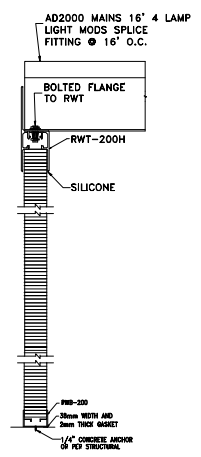

1 WALL SECTION  
 W/A

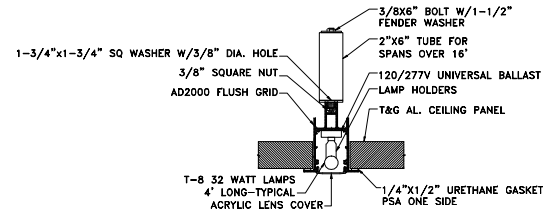

3 AD2000 GRID SUPPORT DETAIL  
 W/A

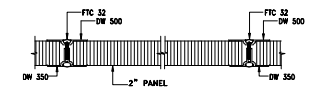

6 HORIZONTAL WALL SECTION  
 W/A

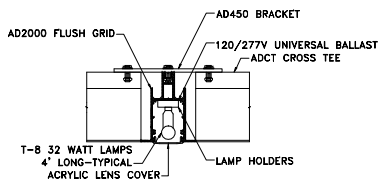

4 AD2000 GRID DETAIL  
 W/A

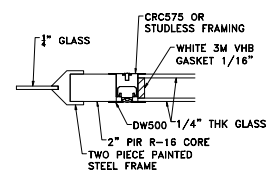

7 SINGLE & FLUSH WINDOW DETAIL  
 W/A

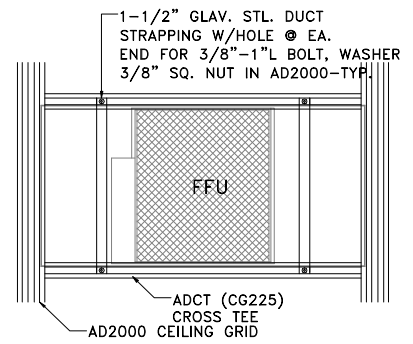

2 FFU SEISMIC ATTACHMENT DETAIL  
 W/A

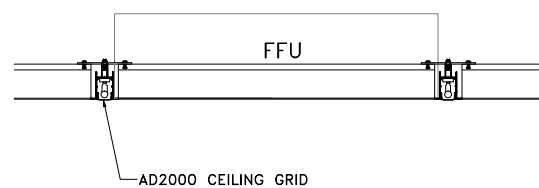

5 PARTIAL CEILING SYSTEM SECTION  
 W/A

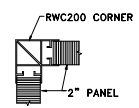

8 RWC200 CORNER DETAIL  
 W/A

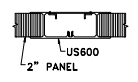

9 US600 SECTION  
 W/A

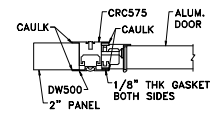

10 DOOR FRAME DETAIL  
 W/A

ISSUED FOR REVIEW 07-12-10

**ARCHITECTURAL  
 DETAILS**

A.3